

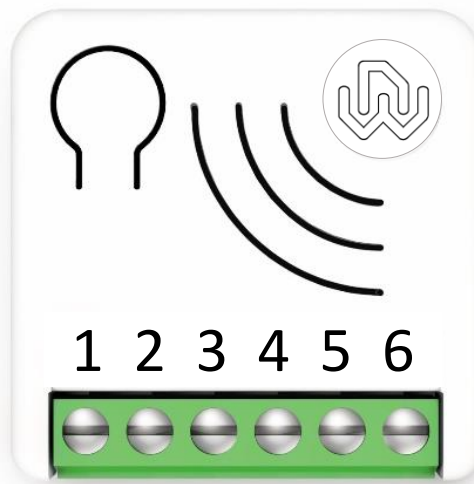

Energy Driven Switch C 7



EDSC700 Operating Instructions



Revision History

Rev. Doc.	Date	Page	Description
0	16/03/22	All	Initial Version
1	16/3/22		Added Meter command Class
2	14/04/22		Update parameters 23, 40, 76
3	06/09/22		Minor description updates Offline setup mode, parameter 42
4	15/11/22		Integrated Max transmitted power update

Content

Revision History	II
Device Description	1
Technical Specifications	2
Safety information	2
Electrical Connections diagram	3
Device Installation	3
LED status indicator	4
Add/Remove the device into a Z-Wave™ network (classic)	4
Standard Inclusion (add)	4
Standard exclusion (remove)	4
SmartStart Inclusion	5
S2 Secure inclusion	5
Supported Command Classes	6
Supporting Command Class Indicator	6
Associations	7
Special features	7
Timer Management	7
Active Energy management	7
Overvoltage Protection	11
Notification Command Class	11
Meter Command Class	11
Offline setup Mode	11
Reset to the factory settings	12
Firmware Update	12
Configurations	13
Output configuration	13
Timer management	13
Local Control	14
Basic Meter configuration	14
Remote control	15

Voltage protection	16
Advanced Meter configuration	16
Meter Report Configuration	18
Disposing the devices	20
Compliance with directives	20
Warranty	20
Legal Notes.....	20

Device Description

Energy Driven Switch C 7 is a device designed to monitor all **parameters, usage, faults and overloads** of your electrical system. Unlike ordinary energy meters, it is a bi-directional meter capable of measuring both the consumed and produced power, equipped with a relay that can be activated to initiate specific scenarios in relation to detected power levels.

The device is equipped with an external current transformer and can measure powers over 10 KW.

- **Active Energy-saving management**

Automatically connects and disconnects a specific load if the established threshold limit is exceeded, or supplies the required power, momentarily excluding non-priority loads.

- **Management and prevention of electrical faults**

Identifies malfunctions based on irregular consumptions and to the maximum time of activity.

- **Electrical overload management**

Notifies or disconnects non-priority loads in the eventuality of system overloads.

Energy Driven Switch C 7 boasts the **lowest energy consumption on the market**.

Similarly to the other Smart Serie 7 devices, it can be fully integrated into pre-existing systems and configured in full integration with the Z-Wave™ home automation ecosystem.

At the same time, it is completely configurable so that it can adapt to the most varied needs while also being ready to be used without needing additional configurations in order to operate.

The device is equipped with contact protection technology (*Zero Crossing*) which reduces the electrical stress on the relay contacts and ensures a longer life. The open / closed switching of the device always occur when the instantaneous value of voltage is 0.

It operates in any Z-Wave™ network with other Z-Wave™/Z-Wave Plus™ certified devices and controllers from any other manufacturer. As a constantly powered node, the device will act as repeater regardless of the vendor in order to increase the reliability of the network.

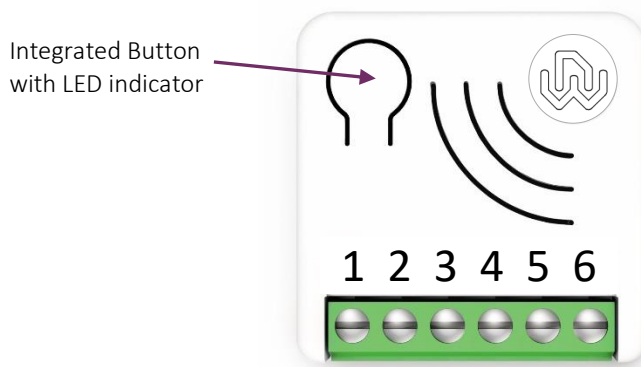

Integrated Button	1 or 3 clicks to enter in Learn Mode 6 clicks to reset the system to manufacturer's settings 2 clicks to enter in setup mode
Power Supply	1 – Null 6 - Line
Output	5 – Line signal referred to Null
Current transformer	2, 3 Connection terminals for external Current Transformer
Terminal not used	4

Technical Specifications

Power Supply	110 - 230 VAC±10% 50/60 Hz
Maximum Load on Relay	3750 VA – 250VAC – 15 A
System temperature limitation	105 °C
Work Temperature	From -10° to 40° C
Power consumption	< 260 mW in standby < 480 mW with working load
Radio frequency	868.4 MHz
Maximum transmitted power	5 dBm
Protection system	S2 Security
Maximum distance	Up to 100 m outdoor Up to 40 m indoor
Dimensions	37x37x17 mm
Actuator element	Relay
Conformity	CE, RoHS
Electrical IP Rating	IP 20

Meter Specifications	
Parameters	Voltage RMS, Current RMS, Active Power, Power Factor, Energy
Meter Range	Voltage RMS: 250 V Current RMS: 45 A Active Power: ± 11250 W Power Factor: ±1.00 Energy: 2.000.000 kWh
Resolution	Voltage RMS: 0.1 V Current RMS: 0.01 A Active Power: 0.01 W Power Factor: 0.01 Energy: 0.001 kWh
Maximum Error (Within the dynamic range)	Voltage (dynamic range 20:1): ±0.95% Current (dynamic range 1000:1): ±2.9% Active Power (dynamic range 4000:1): <ul style="list-style-type: none"> • PF=1: ±4% • PF=0.8: ±5.5%





Safety information



INFO: The device is designed to be installed in flush mounting junction boxes, close to the loads to be controlled, at the point of entry of the electric network sections to be monitored.





WARNING: The device must be installed by electricians qualified to operate on electrical systems in compliance with safety requirements set out by current regulations.

-  **DANGER:** The device must be connected to 230V AC, before carrying out any operation, please make sure that the power main switch is in **OFF** position.
-  **DANGER:** Any procedure requiring the use of the Integrated Button is related only to the installation phase and is to be considered a service procedure that must be performed by qualified personnel. This operation must be performed with all necessary precautions for operating in areas with a single level of insulation.
-  **WARNING:** Do not connect loads exceeding the maximum power load permitted by the relay contacts.
-  **WARNING:** All connections must be performed according to the electrical diagrams provided.
-  **WARNING:** The device must be installed in norm-compliant systems suitably protected from overloads and short circuits.

Electrical Connections diagram

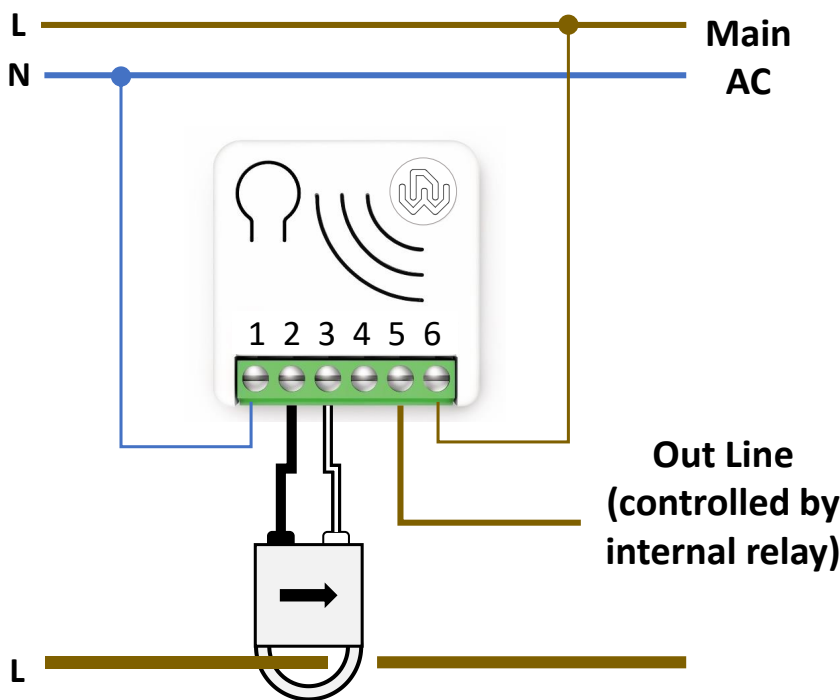
Energy Driven Switch C 7 must be supplied by phase and neutral. Connections must be made according to the diagram below.



-  The current transformer must be clamped on the phase wire leading to the load and adjusted to have the arrow pointing towards the load to be monitored.

Power Supply	1- Null, 6- Line
Output Loads	5 Line signal referred to Null
External current transformer	2 Black terminal, 3 White terminal
Terminal not used	4

Device Installation

- 1) Make sure the main switch is set to the OFF position
- 2) Connect the device based on the diagram provided above

- 3) Turn the main switch to the ON position
- 4) Include the device into the Z-Wave™ network



TIP: The antenna must not be shortened, removed or modified. To ensure maximum efficiency, it must be installed as shown. Large size metal equipment near the antenna can negatively affect reception. Each device is a node in a mesh network. If there are metal obstacles, the obstacle can often be overcome with a further triangulation node.

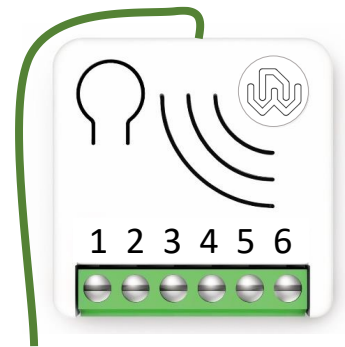

LED status indicator

The system includes an RGB LED that shows the device's status during installation:

Solid RED: the device is not included in any network

Solid BLUE: the device is Offline setup mode

4 GREEN blinks then OFF: the device has been just added to a Z-Wave™ network in S2 Authenticate Mode

4 BLUE blinks then OFF: the device has been just added to a Z-Wave™ network in S2 Unauthenticated Mode

4 RED blinks then OFF: the device has been just added to a Z-Wave™ network without security

Sequence of GREEN-BLUE Learn Mode for inclusion

Sequence of RED-BLUE Learn Mode for exclusion



INFO: The *Learn Mode status* is activated or deactivated by a single or triple click on the integrated button.

Add/Remove the device into a Z-Wave™ network (classic)

Standard Inclusion (add)

All Smart Serie 7 devices are compatible with all Z-Wave™/Z-Wave Plus™ certified controllers. The devices support both the **Network Wide Inclusion** mechanism (which offers the ability to be included in a network, even if the device is not directly connected to the controller) and **Normal Inclusion**.

By default, the inclusion procedure starts in **Normal Inclusion** mode and after a short timeout the procedure continues in **Network Wide Inclusion** mode that lasts for about 20 Seconds.

Only a controller can add the device into the network. After activating the inclusion function by the controller, the device can be added by setting it in **Learn Mode**.

Before including the device, the LED status indicator is solid RED. The adding of a device is executed by activating the adding procedure in the inclusion section of the controller interface and executing 1 or 3 click on the integrated button (the device is set in **Learn Mode**). As soon as the inclusion procedure initiates the LED indicator starts a sequence of GREEN-BLUE blinks. The device is included in the network when the LED status is OFF and the interview is completed.

Standard exclusion (remove)

Only a controller can remove the device from the network. After activating the exclusion function by the controller, the device can be removed by setting it in **Learn Mode**.

The procedure of exclusion can be activated by **Removing** a node from the Z-Wave™ network and executing 1 or 3 click on the integrated button; as soon as the exclusion initiates, the LED indicator starts a sequence of RED-BLUE blinks. The device is excluded from the network when the LED status indicator is solid RED and the App_status in the interface is OK.

SmartStart Inclusion

Z-Wave™ SmartStart aims to shift the tasks related to inclusion of an end device into a Z-Wave™ network away from the end device itself, and towards the more user-friendly interface of the gateway.

Z-Wave™ SmartStart removes the need for initiating the end device to start inclusion. Inclusion is initiated automatically on power-ON and repeated at dynamic intervals for as long as the device is not included into a Z-Wave™ network. As the new device announces itself on power-ON, the protocol will provide notifications, and the gateway can initiate the inclusion process in the background, without the need for user interaction or any interruption of normal operation. The Smart Start inclusion process only includes authenticated devices.

Smart Serie 7 devices can be added into a Z-Wave™ network by scanning the Z-Wave™ QR Code present on the product with a controller providing SmartStart inclusion. No further action is required and the SmartStart product will be added automatically within 10 minutes of being switched on in the network vicinity.

The SmartStart QR and the full DSK string code can be found on the back of the device. The PIN is the first group of 5 digits printed underlined. If you plan to use the DSK, it is important that you take a picture of the label and keep it in a safe place.

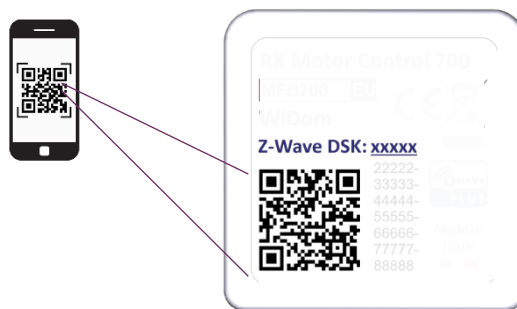

S2 Secure inclusion

When adding Smart Serie 7 devices to a Z-Wave™ network with a controller supporting Security 2 Authenticated (S2), the PIN code of the Z-Wave™ Device Specific Key (DSK) is required. The unique DSK code is printed on the product label. The first five digits of the key are highlighted and underlined to help the user identify the PIN code

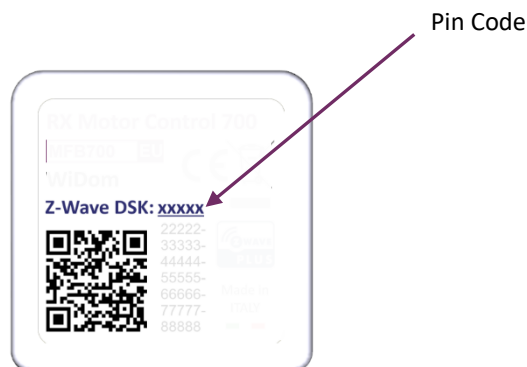

Supported Command Classes

Command Class	Version	Non-Secure CC	Secure CC
ZWAVEPLUS_INFO	2	x	
ASSOCIATION	2		x
MULTI_CHANNEL_ASSOCIATION_V2	3		x
ASSOCIATION_GRP_INFO	3		x
TRANSPORT_SERVICE	2	x	
VERSION	3		x
MANUFACTURER_SPECIFIC	2		x
DEVICE_RESET_LOCALLY	1		x
INDICATOR	3		x
POWERLEVEL	1		x
SECURITY_2	1	x	
SUPERVISION	1	x	
FIRMWARE_UPDATE_MD	5		x
APPLICATION_STATUS	1	x	
CONFIGURATION_V4	4		x
NOTIFICATION	8		x
METER	5		x

Supporting Command Class Indicator

The device supports Indicator V3 with Indicator ID 0x50 (identity). When the device receives an indicator set, the led blinks accordingly to the Indicator set received.

The color shown by the indicator will be:

RED: if the device is included without Security

BLUE: if the device is included in S2 Unauthenticated Mode

GREEN: if the device is already included in S2 Authenticate Mode

Associations

Energy Driven Switch C 7 can control other devices such as relays or dimmers. The device supports 5 association groups, each of which supports the association of 5 nodes

Group ID	Group Name	N° of max nodes supported in the group	Description	Command sent
1	Lifeline	5	Lifeline Group Devices to receive notifications on: energy and power levels; device local reset; and indicator notification	DEVICE RESET LOCALLY NOTIFICATION, METER REPORT, INDICATOR REPORT
2	Up Power Detected G1	5	G1 and G2 group are controlled in sequence, after a user defined delay, in the case of an Up Power Event	BASIC_SET
3	Up Power Detected G2	5		
4	Down Power Detected G1	5	G1 and G2 group are controlled in sequence, after a user defined delay, in the case of a Down Power Event	BASIC_SET
5	Down Power Detected G2	5		



INFO: Association ensures direct transfer of control commands between devices and is performed without participation of the main controller.

Special features

Timer Management

The device has a timer that can be configured to turn ON and/or OFF the local relay. The timer starts its counter after a relay commutation.

Active Energy management

Energy Driven Switch C 7 can implement an active energy saving policy by managing electric loads in order to maximize the self-consumption during the greater production period of a wind power or photovoltaic plant, optimizing the net metering and the energy saving. Refer to the configuration section for the parameter details.

The system implements a control logic of the associated loads through load controlled directly by the integrated relay, and the association groups which is based on the following logic:

The Up Power G1 and Up Power G2 groups are controlled if an Up Power event occurs.

The Down Power G1 and Down Power G2 groups are controlled if a Down Power event occurs.

The Up Power and Down Power events are defined based on the power value *above / below* a certain level, over a certain period of time.

Both the power levels and the time thresholds of permanence are defined by the user.

In case the device recognizes an UP/DOWN Power event threshold, it tries to overcome the situation, by controlling in sequence the:

1. Integrated relay
2. UP/DOWN G1 group
3. UP/DOWN G2 group

The command sent during the controlling sequence can be configured by the user as the first timeout generates the event and the next timeout passes at the next controlling step.

The *Up/Down Power First Timeout* is always to be considered as *Local Control* on the relay, even if the relay is not connected to a load.

The *Up/Down Power Next Timeout* is always to be considered for both *G1 and G2 groups* in sequence after the Local Up/Down Power First Timeout.

The minimum time after which the group that has been commanded can be re-commanded, is defined as Protection Time.

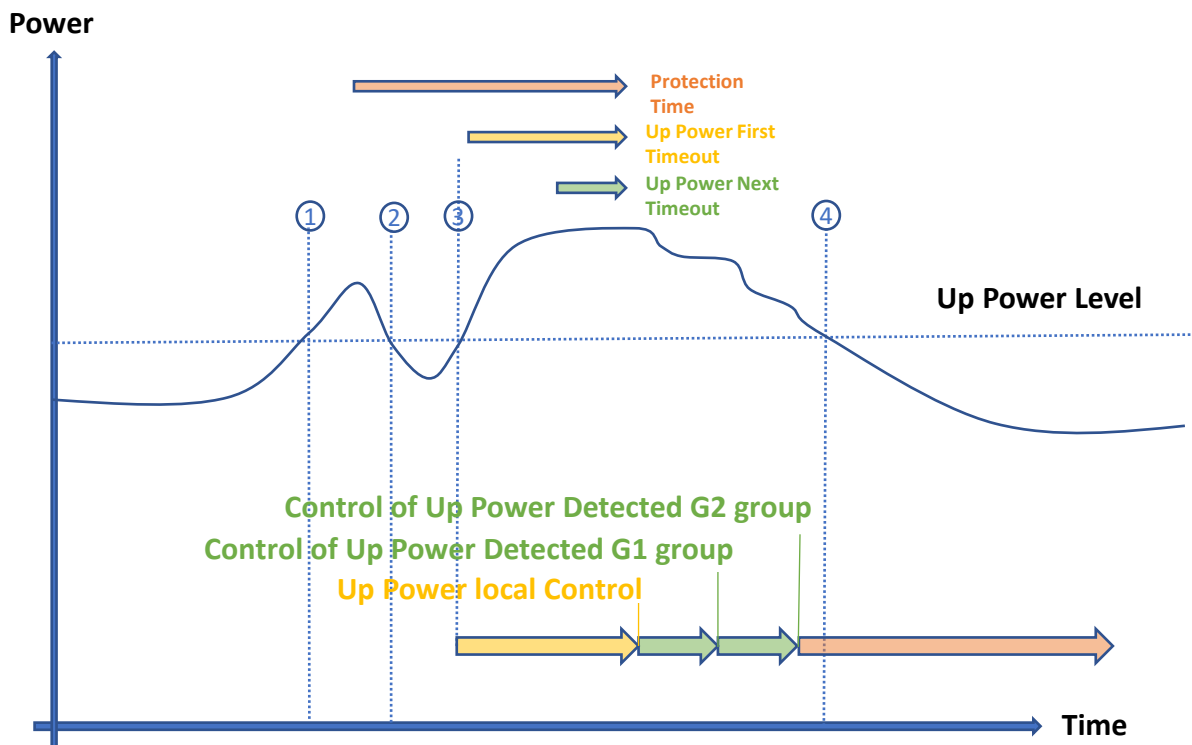

At point 1 the instantaneous power is above the threshold defined by Up Power Level, but the permanence above this level, ending in point 2, is less than the minimum time defined by Up Power First Timeout for the Up Power event to occur.

At point 3 the power is again above the threshold and remains so up to point 4.

After the Up Power First Timeout starting from point 3, the Up Power event which controls the **local relay** is triggered.

Since the power level is still above the threshold after the following Up Power Next Timeout duration, the control of the nodes associated with Group 1 is activated, and then the control of the nodes associated with Group 2.

The control sequence Local, G1, G2 stops as soon as the power returns below the threshold.

If the power remains above the threshold and it does so for longer than the Protection time, the control sequence will be repeated. Once the power drops below the threshold value, to activate a new control sequence, it is necessary to wait for at least a time equal to the Protection Time.

An upper and lower power threshold can be configured which, when exceeded, activates, or deactivates the two groups of loads connected to the two thresholds.

Predefined loads can be disconnected when the power consumed exceeds a specific threshold for longer than a certain amount of time, or specific loads can be activated when the level of energy produced and not consumed exceeds a second threshold.

The device allows you to detect irregular consumption to prevent or identify faults by means of specific alarms.

Example 1: Avoid auto power cut-off for overload.

Configure the device so that, if the consumed power remains above 3 kWh for more than 10 seconds, it can initiate the following sequence of activities:

1. Activate a siren / alarm connected to the integrated relay,
2. If the event persists for further 10 seconds, disconnect a first group of loads (G1 GROUP)
3. If the event persists after further 10 seconds, disconnect a second group of loads (G2 GROUP)

Device configuration for example 1:

Add the devices that control the first and second load respectively in the G1 Up Power Level and G2 Up Power Level association groups and set the following configuration parameters.

Parameter	Description
50 (UP Power Level)	Set to 3000 the power level above which the timer starts counting
52 (UP_POWER_FIRST_TIMEOUT)	Set the first timeout to 10 seconds, relating to the time spent above the UP Power event
40 (UP_POWER_LOCAL_CONTROL)	Set the value to 1, so that the load connected to the integrated relay is switched ON (in this case it is a siren / alarm)
53 (UP_POWER_NEXT_TIMEOUT)	Set to 10 seconds the subsequent timeouts, for sending commands to the groups Up Power Level G1 and then G2
44 (UP_POWER_REMOTE_CONTROL)	Set the value to 0 so that the switch OFF command is sent to the devices included in the Up Power G1 and G2 groups

Example 2: Usage optimization of Energy Production and its usage.

Configure the device so that if the produced power exceeds 1,3 kW for more than 1 minute, a first load is switched ON (e.g. the water heater), and if after 3 minutes the consumed power is below 2 kW a second load is switched ON (e.g. the air conditioner)

The graph below describes the example in a simplified way:

When the produced power is higher than 1,3 kW, both conditions of consumption below 2 kW “Consumed Down Power Level” and production above 1,3 kW “Produced UP Power Level” are verified. The activation times of the loads are configured so that, if the Produced UP Power Level event is still present after 1 minute, the first remote load is switched ON (in point 1), and after 3 minutes of persistence of the Consumed Down Power Level event, the second load is also switched ON (point 2).

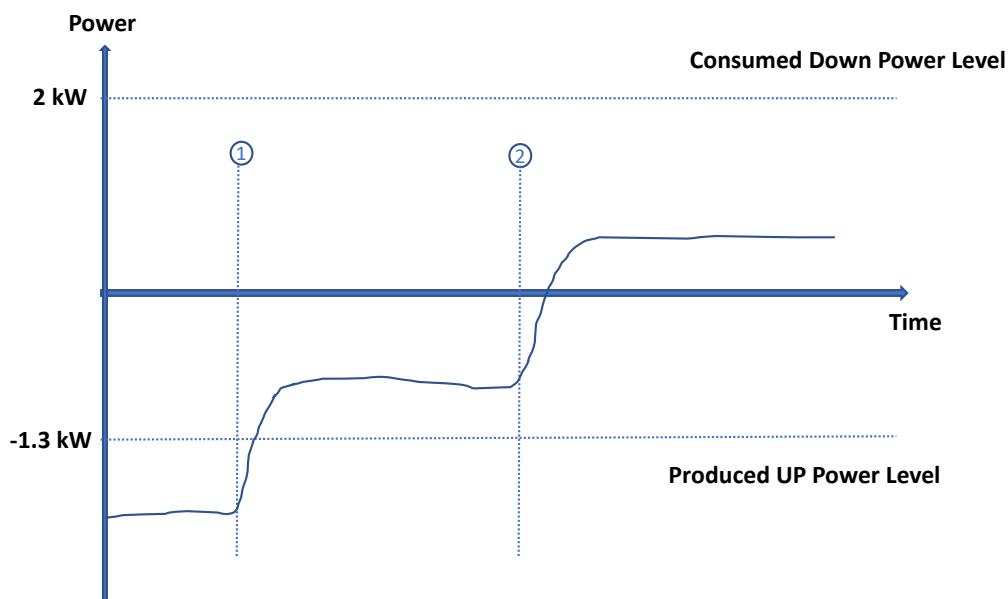

Device configuration for example 2:

Add in the association groups G1 Up Power Level and G1 Down Power Level the devices that control respectively the first load and the second load and set the following configuration parameters.

Parameter	Description
42 (METER_TYPE)	Set the value to 0 so that the device distinguishes between produced and consumed power.
50 (UP_POWER_LEVEL)	Set to 1300 the power level above which the timer starts counting
51 (UP_POWER_TYPE)	Set the value to 1 so that the level of power produced is considered for the Up Power level
52 (UP_POWER_FIRST_TIMEOUT)	Set the First Timeout to 2 seconds, relating to the time spent above the UP Power event produced (minimum value allowed 2 seconds)
53 (UP_POWER_NEXT_TIMEOUT)	Set to 58 seconds the next Timeout for sending commands to the G1 Up Power Level group. (The value takes into account the 2 seconds delay due to the minimum value of the first timeout.)
44 (UP_POWER_REMOTE_CONTROL)	Set the value to 100 for remote control of the device belonging to the G1 Up Power Level group for switching it ON
54 (DOWN_POWER_LEVEL)	Set to 2000 the power level below which the timer starts counting
55 (DOWN_POWER_TYPE)	Set the value to 0 so that the level of power consumed is considered for the Down Power level
56 (DOWN_POWER_FIRST_TIMEOUT)	Set the first timeout to 2 seconds, relating to the time spent under the Down Power consumed event (minimum value allowed 2 seconds)
57 (DOWN_POWER_NEXT_TIMEOUT)	Set to 178 seconds the next timeout for sending commands to the G1 Down Power Level group. (The value takes into account the 2 second delay due to the minimum value of the first time out.)
45 (DOWN_POWER_REMOTE_CONTROL)	Set the value to 100 for remote control of the device belonging to the G1 Down Power group for switching it ON

Overvoltage Protection

The product can be configured to detect if the voltage remains within a range defined by the user, who can set an Overvoltage limit (parameter 46) and a Down voltage limit (parameter 47). When the voltage values go out of the defined range, a notification is sent to the Lifeline association group.

In the following diagram is shown an example of device behavior:

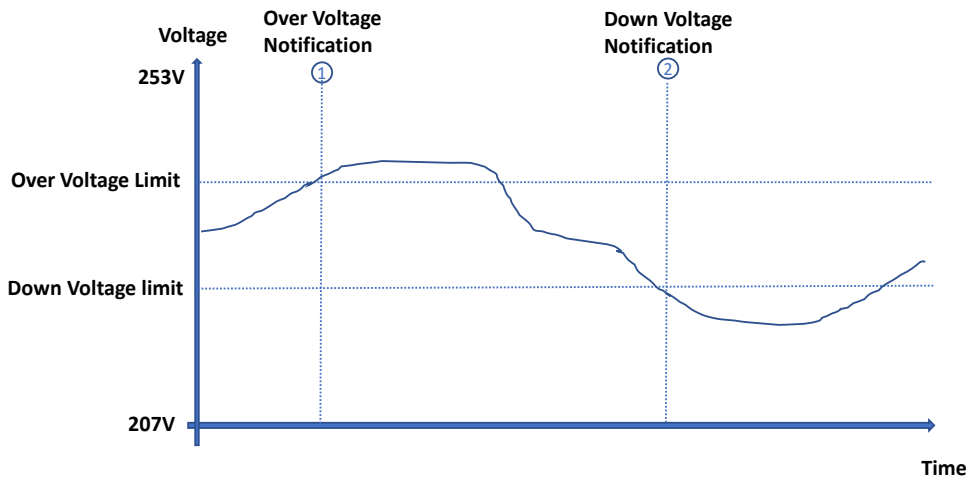

At point 1 the device detects an Overvoltage so it sends an Overvoltage Notification.

In the same way, at point 2 the device will send a Down Voltage Notification.

Notification Command Class

The product supports the Notification Command Class for POWER_MANAGEMENT Type and the Following Events:

Event	Description
OVERVOLTAGE_DETECTION	The event is Sent when an Overvoltage has been recognized. The over Voltage default value is 253 Volt and can be changed by the user with the parameter OVER_VOLTAGE_LIMIT
VOLTAGE_DROP_DRIFT	The event is Sent when a Low voltage has been recognized. The low Voltage default value is 207 Volt and can be changed by the user with the parameter LOW_VOLTAGE_LIMIT
OVERLOADED_DETECTED	The event is Sent when an Over Load has been recognized. This event is disabled by default but can be enabled by using the parameter UP_POWER_LEVEL. The same alert is send also when the produced power overcomes the up power level and the UP_POWER_TYPE parameter is set to on the produced power.

Meter Command Class

The product supports the meter command class and KWh is the default scale report send when the scale type is not present in the received Get.

Offline setup Mode

The device has a unique feature that allows to configure some parameters without using any user interface. This feature enables the professional user to setup the main features of the device in the field even if the device is not included in a

Z-Wave™ Network. When the device will be included in the network all these configuration parameters will be maintained.

To enter in *Offline Setup Mode*, operate 2 clicks on the integrated button.

When the device is in Offline setup mode the LED becomes solid Blue and the following configurations are permitted:

1 click	Automated energy load control. The device will be configured to switch ON the relay if the measured Load is over 3,3 kW for more than 10 Second
2 clicks	Automated energy load control. The device will be configured to switch ON the relay if the measured Load is over 6,6 kW for more than 10 Second
After receiving the command, the LED blinks a number of times equal to the number of clicks recognized	
6 clicks	Exit from Offline setup mode and return to normal operation
Hold down for 5 seconds	Reset all configuration parameters to their default value and return to normal operation

After entering in Offline setup mode, the device returns to normal operation if no action on the switch is detected for more than 20 Seconds.

Reset to the factory settings

The device can be reset to the original factory settings with 6 consecutive clicks on the integrated button. After the reset is completed, the device will reboot and a **RED** solid led is showed.

Please use this procedure only when the network primary controller is missing or otherwise inoperable.



INFO: If the reset is performed while the device is still part of a network, it notifies the other devices that it has been removed (*Device Reset Locally Notification*).

Firmware Update

The system supports over-the-air firmware updates that do not require the device to be removed from its location. The firmware update can be activated from all certified controllers supporting version 2 of the Firmware Update function.



WARNING: The system will be rebooted at the end of the firmware update procedure. It is advisable to carry out the firmware update procedure only when necessary and following careful planning of the intervention.

Configurations

Output configuration

Parameter Number	Size	Parameter Name	Default Value	Description
21	1	OUT_TYPE	0	Define the output type.
Parameters Values			Min: 0	Max: 1
Value	Description			
0	direct load control or normally Open relay			
1	normally Closed relay			

Parameter Number	Size	Parameter Name	Default Value	Description
23	1	STARTUP_OUT	0	Define the output level on startup
Parameters Values			Min: 0	Max: 2
Value	Description			
0	OFF			
1	ON			
2	Previous status			

Timer management

Parameter Number	Size	Parameter Name	Default Value	Description
31	4	OFF_TIMEOUT	0	Time in tenth of second after which the output will be switched Off.
Parameters Values			Min: 0	Max: 360000
Value	Description			
0	Disabled			
1-360000	Specific time expressed in tenth of seconds for Status change			

Parameter Number	Size	Parameter Name	Default Value	Description
32	4	ON_TIMEOUT	0	Time in tenth of second after which the output will be switched On.
Parameters Values			Min: 0	Max: 360000
Value	Description			
0	Disabled			
1-360000	Specific time expressed in tenth of seconds for Status change			

Local Control

Parameter Number	Size	Parameter Name	Default Value	Description
40	1	UP_POWER_LOCAL_CONTROL	1	The value used to control the integrated Relay in case of Up Power Event.
Parameters Values			Min: 0	Max: 1
Value	Description			
0	OFF			
1	ON			

Parameter Number	Size	Parameter Name	Default Value	Description
41	1	DOWN_POWER_LOCAL_CONTROL	1	The value used to control the integrated Relay in case of Down Power Event
Parameters Values			Min: 0	Max: 1
Value	Description			
0	OFF			
1	ON			

Basic Meter configuration

Parameter Number	Size	Parameter Name	Default Value	Description
42	1	METER_TYPE	3	Defines how positive and negative power is treated
Parameters Values			Min: 0	Max:
Value	Description			
0	as is (The device is connected in a bidirectional system and you want to measure consumed and produced energy)			
1	negative value is considered 0 (The device is connected in a bidirectional system, but you are interested only in consumed energy)			
2	positive value is considered 0 (The device is connected in a bidirectional system, but you are interested only in produced energy)			
3	All values are considered positive (The device is connected in a system that only consumes Energy)			
4	All values are considered negative (The device is connected in a system that only produces Energy)			

Parameter Number	Size	Parameter Name	Default Value	Description
43	1	CT_TYPE	1	Define the Model of Current Transformer connected to the device
		Parameters Values	Min: 1	Max: 2
Value	Description			
1	Standard Type			
2	Type 2 version			

Remote control

Parameter Number	Size	Parameter Name	Default Value	Description
44	1	UP_POWER_REMOTE_CONTROL	0	The value used to control Up Power Group
		Parameters Values	Min: 0	Max: 100
Value	Description			
0-99	Specific value (where 0 equals OFF)			
100	ON			

Parameter Number	Size	Parameter Name	Default Value	Description
45	1	DOWN_POWER_REMOTE_CONTROL	100	The value used to control Down Power Group
		Parameters Values	Min: 0	Max: 100
Value	Description			
0-99	Specific value (where 0 equals OFF)			
100	ON			

Voltage protection

Parameter Number	Size	Parameter Name	Default Value	Description
46	2	OVER_VOLTAGE_LIMIT	2530	Define the Over Voltage Limit in tenth of volt
Parameters Values			Min: 900	Max: 2530
Value	Description			
900-2530	Over Voltage limit			

Parameter Number	Size	Parameter Name	Default Value	Description
47	2	DOWN_VOLTAGE_LIMIT	2070	Define the Down Voltage Limit in tenth of volt
Parameters Values			Min: 900	Max: 2530
Value	Description			
900-2530	Down Voltage limit			

Advanced Meter configuration

Parameter Number	Size	Parameter Name	Default Value	Description
50	4	UP_POWER_LEVEL	0	Sets the level of Watts beyond which time of permanence above this level is calculated
Parameters Values			Min: 0	Max: 100000
Value	Description			
0	Up Power Event Disabled			
1-100000	Instantaneous power in Watts			

Parameter Number	Size	Parameter Name	Default Value	Description
51	1	UP_POWER_TYPE	0	Defines if the Up Power is consumed or produced
Parameters Values			Min: 0	Max: 1
Value	Description			
0	Consumed			
1	Produced			

Parameter Number	Size	Parameter Name	Default Value	Description
52	2	UP_POWER_FIRST_TIMEOUT	30	Defines the time of permanence in seconds above the Up power level after which the First Up Power event occurs
Parameters Values		Min: 2		Max: 7200
Value	Description			
2-7200	Specific time expressed in seconds			

Parameter Number	Size	Parameter Name	Default Value	Description
53	2	UP_POWER_NEXT_TIMEOUT	5	Defines the time of permanence in seconds above the Up power level after which the Next Up Power event occurs
Parameters Values		Min: 2		Max: 7200
Value	Description			
2-7200	Specific time expressed in seconds			

Parameter Number	Size	Parameter Name	Default Value	Description
54	4	DOWN_POWER_LEVEL	0	Sets the level of Watts beyond which time of permanence below this level is calculated
Parameters Values		Min: 0		Max: 100000
Value	Description			
0	Down Power Event Disabled			
1-100000	Instantaneous power in Watt			

Parameter Number	Size	Parameter Name	Default Value	Description
55	1	DOWN_POWER_TYPE	0	Defines if the Down Power is consumed or produced
Parameters Values		Min: 0		Max: 1
Value	Description			
0	Consumed			
1	Produced			

Parameter Number	Size	Parameter Name	Default Value	Description
56	2	DOWN_POWER_FIRST_TIMEOUT	30	Defines the time of permanence in seconds below the Down Power level after which the first Down Power event occurs
Parameters Values			Min: 2	Max: 7200
Value	Description			
2-7200	Specific time expressed in seconds			

Parameter Number	Size	Parameter Name	Default Value	Description
57	2	DOWN_POWER_NEXT_TIMEOUT	5	Defines the time of permanence in seconds below the Down Power level after which the next Up Down event occurs
Parameters Values			Min: 2	Max: 7200
Value	Description			
2-7200	Specific time expressed in seconds			

Parameter Number	Size	Parameter Name	Default Value	Description
58	2	PROTECTION_TIME	60	Define the minimum time in seconds, after which an Up/Down Power Event can be triggered again
Parameters Values			Min: 2	Max: 3600
Value	Description			
2-3600	Protection time in seconds			

Meter Report Configuration

Parameter Number	Size	Parameter Name	Default Value	Description
71	1	METER_REPORT_MAX_DELAY	10	The Maximum Time in minutes after which the next Meter sequence report will be sent
Parameters Values			Min: 1	Max: 120
Value	Description			
1-120	The maximum delay in minutes from a sequence of meter report and the next			

Parameter Number	Size	Parameter Name	Default Value	Description
75	1	METER_INSTANT_REPORT	20	The percentage of Power change from the last sent report that triggers a new meter report sequence
Parameters Values			Min: 0	Max: 100
Value	Description			
0	No report is sent (for any power change)			
1-100	The percentage of Power change from the last sent report that triggers a new meter report sequence			

Parameter Number	Size	Parameter Name	Default Value	Description
76	1	REPORT_CONFIG	117	Define which Report scale will be sent
Parameters Values			Min: 0	Max: 117
Value	Description			
0	none			
1	Energy			
4	Power			
16	Voltage			
32	Current			
64	Power Factor			
<p>If you want to receive more than 1 scale, the value for the configuration parameter is the sum of the event values. For example: If you want to receive the Energy and Power reports -> Parameter value must be $1 + 4 = 5$ If you want to receive the Voltage and Current reports -> Parameter value must be $16 + 32 = 48$ Default value: 117 (to receive all reports)</p>				

Disposing the devices

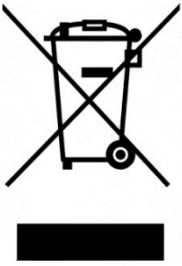

This product bears the selective sorting symbol for waste electrical and electronic equipment (WEEE) and must be handled pursuant to European Directive WEEE in order to be recycled or dismantled to minimize its impact on the environment.

For further information, please contact your local or regional authorities.

Electronic products not included in the selective sorting process are potentially dangerous for the environment and human health due to the presence of hazardous substances.

Compliance with directives

WiDom Srl declares that Energy Driven Switch C 7 is built in compliance with directive 2014/53/EU. The complete version of the Declaration of Conformity is available at the following internet address: <https://support.widom.it/energy-driven-switch-c-serie-700-doc/>

Warranty

For detailed information on the warranty please refer to the *Standard Warranty Conditions* indicated in company's website at www.widom.it.

Please check at www.widom.it the newest version of this document.

Legal Notes

WiDom Srl shall not be held responsible for any damage caused by these devices if they are used in a manner that is not compliant with the instructions in this manual. WiDom Srl reserves the right to make any changes to the product that it considers necessary or useful without jeopardizing its primary features, to change characteristics and technical specifications without notice, and is not responsible for any graphic or typographical errors that that may appear in this document.

WiDom Srl

Adress: Via Mameli 88 - 09123 - Cagliari (ITALIA)

E-mail: info@widom.it

Tel: +39 0702057916